

SERVICE MANUAL

**T6.120 / T6.140 / T6.150 / T6.155 /
T6.160 / T6.165 / T6.175 /
T6.140 AutoCommand / T6.150 AutoCommand /
T6.160 AutoCommand
Tier 4A
Tractor**

ENGINE - 10
CLUTCH - 18

Part number 47720737

English

March 2014

Replaces part number 47486161





INTRODUCTION

Contents

INTRODUCTION

Foreword	3
Foreword - How to use and navigate through this manual	4
Foreword Ecology and the Environment	9
Safety rules	10
Torque	14
Basic instructions	16
Conversion factors	18
Consumables Lubrications and Coolants	19
Capacities	22

Foreword

IMPORTANT INFORMATION

All repair and maintenance works listed in this manual must be carried out only by staff belonging to the NEW HOLLAND Service network, strictly complying with the instructions given and using, whenever required, the special tools.

Anyone who carries out the above operations without complying with the prescriptions shall be responsible for the subsequent damages.

The manufacturer and all the organizations of its distribution chain, including - without limitation - national, regional or local dealers, reject any responsibility for damages due to the anomalous behavior of parts and/or components not approved by the manufacturer himself, including those used for the servicing or repair of the product manufactured or marketed by the Manufacturer. In any case, no warranty is given or attributed on the product manufactured or marketed by the Manufacturer in case of damages due to an anomalous behavior of parts and/or components not approved by the Manufacturer.

No reproduction, though partial of text and illustrations allowed.

Foreword - How to use and navigate through this manual

This manual has been produced by a new technical information system. This new system is designed to deliver technical information electronically through web delivery (eTIM), DVD, and paper manuals. A coding system called SAP has been developed to link the technical information to other Product Support functions, e.g., Warranty.

Technical information is written to support the maintenance and service of the functions or systems on a customer's machine. When a customer has a concern on their machine it is usually because a function or system on their machine is not working at all, is not working efficiently, or is not responding correctly to their commands. When you refer to the technical information in this manual to resolve that customer's concern, you will find all the information classified using the SAP coding, according to the functions or systems on that machine. Once you have located the technical information for that function or system, you will then find all the mechanical, electrical or hydraulic devices, components, assemblies, and sub assemblies for that function or system. You will also find all the types of information that have been written for that function or system: the technical data (specifications), the functional data (how it works), the diagnostic data (fault codes and troubleshooting), and the service data (remove, install adjust, etc.).

By integrating SAP coding into technical information, you will be able to search and retrieve just the right piece of technical information you need to resolve that customer's concern on his machine. This is made possible by attaching 3 categories to each piece of technical information during the authoring process.

The first category is the Location, the second category is the Information Type and the third category is the Product:

- LOCATION - the component or function on the machine, that the piece of technical information is going to describe (e.g., Fuel tank).
- INFORMATION TYPE - the piece of technical information that has been written for a particular component or function on the machine (e.g., Capacity would be a type of Technical Data describing the amount of fuel held by the fuel tank).
- PRODUCT - the model for which the piece of technical information is written.

Every piece of technical information will have those three categories attached to it. You will be able to use any combination of those categories to find the right piece of technical information you need to resolve that customer's concern on their machine.

That information could be:

- the procedure for how to remove the cylinder head
- a table of specifications for a hydraulic pump
- a fault code
- a troubleshooting table
- a special tool

Manual content

This manual is divided into Sections. Each Section is then divided into Chapters. Contents pages are included at the beginning of the manual, then inside every Section and inside every Chapter. An alphabetical Index is included at the end of each Chapter. Page number references are included for every piece of technical information listed in the Chapter Contents or Chapter Index.

Each Chapter is divided into four Information types:

- Technical Data (specifications) for all the mechanical, electrical or hydraulic devices, components, assemblies or sub-assemblies.
- Functional Data (how it works) for all the mechanical, electrical or hydraulic devices, components, assemblies or sub-assemblies.
- Diagnostic Data (fault codes, electrical and hydraulic troubleshooting) for all the mechanical, electrical or hydraulic devices, components, assemblies or sub-assemblies.
- Service Data (remove disassemble, assemble, install) for all the mechanical, electrical or hydraulic devices, components, assemblies or sub-assemblies.

Sections

Sections are grouped according to the main functions or a systems on the machine. Each Section is identified by a number (00, 35, 55, etc.). The Sections included in the manual will depend on the type and function of the machine that the manual is written for. Each Section has a Contents page listed in alphabetic/numeric order. This table illustrates which Sections could be included in a manual for a particular product.

SECTION	PRODUCT				
	Tractors				
	Vehicles with working arms: backhoes, excavators, skid steers,				
	Combines, forage harvesters, balers,				
	Seeding, planting, floating, spraying equipment,				
	Mounted equipment and tools,				
00 - Maintenance	X	X	X	X	X
05 - Machine completion and equipment	X	X	X	X	X
10 - Engine	X	X	X	X	
14 - Main gearbox and drive	X	X	X	X	
18 - Clutch	X	X	X		
21 - Transmission	X	X	X	X	
23 - Four wheel drive (4WD) system	X	X	X	X	
25 - Front axle system	X	X	X	X	
27 - Rear axle system	X	X	X	X	
29 - Hydrostatic drive	X	X	X	X	
31 - Power Take-Off (PTO)	X		X		
33 - Brakes and controls	X	X	X	X	
35 - Hydraulic systems	X	X	X	X	
36 - Pneumatic system	X	X	X	X	
37 - Hitches, drawbars and implement couplings	X		X	X	
39 - Frames and ballasting	X	X	X	X	X
41 - Steering	X	X	X	X	
44 - Wheels	X	X	X	X	
46 - Steering clutches					
48 - Tracks and track suspension	X	X	X		
50 - Cab climate control	X	X	X	X	
55 - Electrical systems	X	X	X	X	X
56 - Grape harvester shaking					
58 - Attachments/headers			X		
60 - Product feeding			X		

INTRODUCTION

61 - Metering system				X	
62 - Pressing - Bale formation			X		
63 - Chemical applicators				X	
64 - Chopping			X		
66 - Threshing			X		
68 - Tying/Wrapping/Twisting			X		
69 - Bale wagons					
70 - Ejection			X		
71 - Lubrication system	X	X	X	X	X
72 - Separation			X		
73 - Residue handling			X		
74 - Cleaning			X		
75 - Soil preparation/Finishing					
76 - Secondary cleaning / Destemmer					
77 - Seeding				X	
78 - Spraying				X	
79 - Planting				X	
80 - Crop storage / Unloading			X		
82 - Front loader and bucket	X	X			
83 - Telescopic single arm	X	X			
84 - Booms, dippers and buckets	X	X			
86 - Dozer blade and arm	X	X			
88 - Accessories	X	X	X	X	X
89 - Tools	X	X	X	X	X
90 - Platform, cab, bodywork and decals	X	X	X	X	

Chapters

Each Chapter is identified by a number e.g. Engine - Engine and crankcase - 10.001. The first number is identical to the Section number i.e. Chapter 10.001 is inside Section 10, Engine. The second number is representative of the Chapter contained within the Section.

CONTENTS

The Chapter Contents lists all the technical data (specifications), functional data (how it works), diagnostic data (fault codes and troubleshooting), and service data (remove, install, adjust, etc.), that have been written in that Chapter for that function or system on the machine.

Contents

	ENGINE	
	ENGINE - Engine and crankcase – 10.001	
TECHNICAL DATA		
ENGINE - Engine and crankcase - General specification (10.001 - D.40.A.10)		4
FUNCTIONAL DATA		
ENGINE - Engine and crankcase - Dynamic description (10.001 - C.30.A.10)		6
SERVICE		
ENGINE - Engine and crankcase - Remove (10.001 -F.10.A.10)		8
DIAGNOSTIC		
ENGINE - Engine and crankcase - Troubleshooting (10.001 - G.40.A.10)		10

INDEX

The Chapter Index lists in alphabetical order all the types of information (called information units) that have been written in that Chapter for that function or system on the machine.

Index

	ENGINE - 10	
	ENGINE	
ENGINE - Engine and crankcase - Dynamic description (10.001 - C.30.A.10)		6
ENGINE - Engine and crankcase - General specification (10.001 - D.40.A.10)		4
ENGINE - Engine and crankcase - Remove (10.001 -F.10.A.10)		8
ENGINE - Engine and crankcase - Troubleshooting (10.001 - G.40.A.10)		10

Information units and information search

Each chapter is composed of information units. Each information unit has the SAP code shown in parentheses. This indicates the function and type of information in that information unit. Each information unit has a page reference within that Chapter. The information units provide a quick and easy way to find just the right piece of technical information you are looking for.

Example information unit	Engine block cover - Front – Remove (10.102.AP.01 - F.10.A.10)					
Information Unit SAP code	10	102	AK	01	F	10.A.10
SAP code classification	Engine	Pan and covers	Engine block cover	Front cover	Service data	Remove

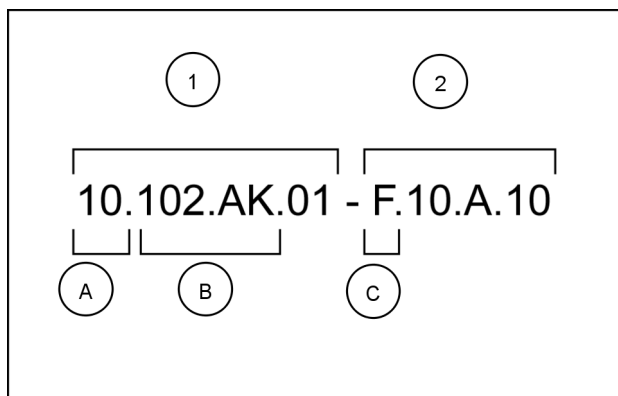

NHIL12GEN0070A 1

Navigate to the correct information unit you are searching for by identifying the function and information type from the SAP code.

- **(1)** Location and **(2)** Information type.
- **(A)** corresponds to the sections of the service manual.
(B) corresponds to the chapters of the service manual. After **(B)** there may be some additional information. In this case it shows “.01”, which represents the “Front” block cover. These options may be front/rear, left/right, hydraulic/mechanical etc.
(C) corresponds to the type of information listed in the chapter contents: Technical Data, Functional Data, Diagnostic, or Service.
(A) and **(B)** are also shown in the page numbering on the page footer.
THE REST OF THE CODING IS NOT LISTED IN ALPHANUMERIC ORDER IN THIS MANUAL.
- You will find a table of contents at the beginning and end of each section and chapter.
You will find an alphabetical index at the end of each chapter.
- By referring to **(A)**, **(B)** and **(C)** of the coding, you can follow the contents or index (page numbers) and quickly find the information you are looking for.

Page header and footer

The page header will contain the following references:

- Section and Chapter description

The page footer will contain the following references:

- Publication number for that Manual.
- Version reference for that publication.
- Publication date
- Section, chapter, and page reference e.g. 10.102 / 9

Foreword Ecology and the Environment

Soil, air, and water are vital factors of agriculture and life in general. When legislation does not yet rule the treatment of some of the substances which are required by advanced technology, common sense should govern the use and disposal of products of a chemical and petrochemical nature.

NOTICE: *The following are recommendations which may be of assistance:*

- Become acquainted with and ensure that you understand the relative legislation applicable to your country.
- Where no legislation exists, obtain information from suppliers of oils, filters, batteries, fuels, antifreeze, cleaning agents, etc., with regard to their effect on man and nature and how to safely store, use and dispose of these substances.
- Agricultural consultants will, in many cases, be able to help you as well.

HELPFUL HINTS

- Avoid filling tanks using cans or inappropriate pressurized fuel delivery systems which may cause considerable spillage.
- In general, avoid skin contact with all fuels, oils, acids, solvents, etc. Most of them contain substances which may be harmful to your health.
- Modern oils contain additives. Do not burn contaminated fuels and or waste oils in ordinary heating systems.
- Avoid spillage when draining off used engine coolant mixtures, engine, gearbox and hydraulic oils, brake fluids, etc. Do not mix drained brake fluids or fuels with lubricants. Store them safely until they can be disposed of in a proper way to comply with local legislation and available resources.
- Modern coolant mixtures, i.e. antifreeze and other additives, should be replaced every two years. They should not be allowed to get into the soil but should be collected and disposed of properly.
- Do not open the air-conditioning system yourself. It contains gases which should not be released into the atmosphere. Your NEW HOLLAND dealer or air conditioning specialist has a special extractor for this purpose and will have to recharge the system properly.
- Repair any leaks or defects in the engine cooling or hydraulic system immediately.
- Do not increase the pressure in a pressurized circuit as this may lead to a component failure.
- Protect hoses during welding as penetrating weld splatter may burn a hole or weaken them, allowing the loss of oils, coolant, etc.

Safety rules

PRECAUTIONARY STATEMENTS

Personal Safety





This is the safety alert symbol. It is used to alert you to potential personal injury hazards. Obey all safety messages that follow this symbol to avoid possible injury or death.

Throughout this manual , you will find the signal words DANGER, WARNING, and CAUTION followed by special instructions. These precautions are intended for the personal safety of you and those working with you.

Read and understand all the safety messages in this manual before you operate or service the machine.

 DANGER indicates a hazardous situation which, if not avoided, will result in death or serious injury.

 WARNING indicates a hazardous situation which, if not avoided, could result in death or serious injury.

 CAUTION, used with the safety alert symbol, indicates a hazardous situation which, if not avoided, could result in minor or moderate injury.

FAILURE TO FOLLOW DANGER, WARNING, AND CAUTION MESSAGES COULD RESULT IN DEATH OR SERIOUS INJURY.

NOTICE: Install new decals if the old decals are destroyed, lost painted over or cannot be read. When parts are replaced that have decals make sure you install a new decal with each new part.

MACHINE SAFETY

NOTICE: Notice indicates a situation which, if not avoided, could result in machine or property damage.

Throughout this manual you will find the signal word Notice followed by special instructions to prevent machine or property damage. The word Notice is used to address practices not related to personal safety.

INFORMATION

NOTE: Note indicates additional information which clarifies steps, procedures, or other information in this manual.

Throughout this manual you will find the word Note followed by additional information about a step, procedure, or other information in the manual. The word Note is not intended to address personal safety or property damage.

ACCIDENT PREVENTION

▲ WARNING

Avoid injury! Always do the following before lubricating, maintaining, or servicing the machine.

- 1. Disengage all drives.**
 - 2. Engage parking brake.**
 - 3. Lower all attachments to the ground, or raise and engage all safety locks.**
 - 4. Shut off engine.**
 - 5. Remove key from key switch.**
 - 6. Switch off battery key, if installed.**
 - 7. Wait for all machine movement to stop.**
- Failure to comply could result in death or serious injury.**

W0047A

Most accidents or injuries that occur in workshops are the result of non compliance to simple and fundamental safety principles. For this reason, IN MOST CASES THESE ACCIDENTS CAN BE AVOIDED by applying the fundamental safety principles, acting with the necessary caution and care.

Accidents may occur with all types of machine, regardless of how well the machine in question was designed and built.

SAFETY REQUIREMENTS FOR FLUID POWER SYSTEMS AND COMPONENTS - HYDRAULICS (EUROPEAN STANDARD EN982)

- Flexible hose assemblies must not be constructed from hoses which have been previously used as part of a hose assembly.
- Do not weld hydraulic pipes: when flexible hoses or piping are damaged, replace them immediately.
- It is forbidden to modify a hydraulic accumulator by machining, welding or any other way.
- Before removing hydraulic accumulators for servicing, the liquid pressure in the accumulators must be reduced to zero.
- Pressure check on hydraulic accumulators must be carried out by a method recommended by the accumulator manufacturer.
- Take care not to exceed the maximum allowed pressure of the accumulator. After any check or adjustment, check for leakages or gas in the hoses or pipes.

SAFETY RULES

General guidelines

- Carefully follow specified repair and maintenance procedures.
- When appropriate, use P.P.E (Personal Protective Equipment)
- Do not wear rings, wristwatches, jewellery, unbuttoned or loose articles of clothing such as: ties, torn clothing, scarves, open jackets or shirts with open zips that may remain entangled in moving parts. It is advised to wear approved safety clothing, e.g.: non-slip footwear, gloves, safety goggles, helmets, etc.
- Do not carry out repair operations with someone sitting in the driver's seat, unless the person is a trained technician who is assisting with the operation in question.
- Do not operate the machine or use any of the implements from different positions, other than the driver's seat.
- Do not carry out operations on the machine with the engine running, unless specifically indicated.
- Bring all hydraulic cylinders to the home positions (down, retracted, etc.) before engine shut down.
- Stop the engine and check that the hydraulic circuits are pressure-free before removing caps, covers, valves, etc.
- All repair and maintenance operations must be carried out using extreme care and attention.
- Service steps and platforms used in the workshop or elsewhere should be built according to the applicable standards and legislation.
- Disconnect the power take off (p.t.o). and label the controls to indicate that the machine is being serviced. Any parts that are to be raised must be locked in position.

INTRODUCTION

- Brakes are inoperative when manually released for repair or maintenance purposes. Use blocks or similar devices to secure the machine in these conditions.
- Only use specified towing points for towing the machine. Connect parts carefully. Make sure that all pins and/or locks are secured in position before applying traction. Never remain near the towing bars, cables or chains that are operating under load.
- When loading or unloading the machine from the trailer (or other means of transport), select a flat area capable of sustaining the trailer or truck wheels. Firmly secure the machine to the truck or trailer and lock the wheels in the position used by the carrier.
- Electric heaters, battery-chargers and similar equipment must only be powered by auxiliary power supplies with efficient ground insulation to avoid electrical shock hazards.
- Always use suitable hoisting or lifting devices when raising or moving heavy parts.
- Keep bystanders away.
- Never use gasoline, diesel oil or other inflammable liquids as cleaning agents. Use non-inflammable, non toxic commercially available solvents.
- Wear safety goggles with side guards when cleaning parts with compressed air.
- Do not run the engine in enclosed spaces without suitable ventilation or exhaust extraction.
- Never use open flames for lighting when working on the machine or checking for leaks.
- All movements must be carried out carefully when working under, on or near the machine. Wear personal protective equipment (P.P.E.): helmets, goggles and special footwear.
- When carrying out checks with the engine running, request the assistance of an operator in the driver's seat. The operator must maintain visual contact with the service technician at all times.
- If operating outside the workshop, position the machine on a flat surface and lock in position. If working on a slope, lock the machine in position. Move to a flat area as soon as is safely possible.
- Damaged or bent chains or cables are unreliable. Do not use them for lifting or towing. Always use suitable protective gloves when handling chains or cables.
- Chains should always be safely secured. Make sure that the hitch-up point is capable of sustaining the load in question. Keep the area near the hitch-up point, chains or cables free of all bystanders.
- Maintenance and repair operations must be carried out in a CLEAN and DRY area. Clean up any water or oil spillage immediately.
- Do not create piles of oil or grease-soaked rags as they represent a serious fire hazard. Always store rags in a closed metal container.
- Before engaging the machine, make sure that there are no persons within the machine or implement range of action.
- Empty your pockets of all objects that may fall accidentally unobserved into the machine inner compartments.
- When metal parts are sticking out, use protective goggles or goggles with side guards, helmets, special footwear and gloves.
- When welding, use protective safety devices: tinted safety goggles, helmets, special overalls, gloves and footwear. All persons present in the area where welding is taking place must wear tinted goggles. NEVER LOOK DIRECTLY AT THE WELDING ARC WITHOUT SUITABLE EYE PROTECTION.
- Always disconnect battery ground terminal when welding.
- Metal cables tend to fray with repeated use. Always use suitable protective devices (gloves, goggles, etc.) when handling cables.

Machine start-up.

- Never run the engine in confined spaces that are not equipped with adequate ventilation for exhaust gas extraction.
- Never place the head, body, limbs, feet, hands or fingers near rotating and moving parts.

Hydraulic systems and fuel injection systems

- A liquid leaking from a tiny hole may be almost invisible but, at the same time, be powerful enough to penetrate the skin. Therefore, NEVER USE HANDS TO CHECK FOR LEAKS but use a piece of cardboard or paper for this purpose. If any liquid penetrates skin tissue, call for medical aid immediately. Failure to treat this condition with correct medical procedure may result in serious infection or death.
- In order to check the pressure in the system use suitable instruments.

Wheels and Tires

- Make sure that the tires are correctly inflated at the pressure specified by the manufacturer. Periodically check the rims and tires for damage.
- Stand away from (at the side of) the tire when checking inflation pressure.
- Do not use parts of recovered wheels as incorrect welding brazing or heating may weaken and eventually cause damage to the wheel.
- Never cut or weld a rim mounted with an inflated tire.
- Deflate the tire before removing any objects that may be jammed in the tire tread.
- Never inflate tires using inflammable gases, as this may result in explosions and injury to bystanders.

Removal and Re-fitting

- Lift and handle all heavy parts using suitable hoisting equipment. Make sure that parts are sustained by appropriate hooks and slings. Use the hoisting eyebolts for lifting operations. Extra care should be taken if persons are present near the load to be lifted.
- Handle all parts carefully. Do not put your hands or fingers between parts. Wear suitable safety clothing - safety goggles, gloves and shoes.
- Avoid twisting chains or metal cables. Always wear safety gloves when handling cables or chains.

Torque

Minimum hardware tightening torques (in N m or lb in /lb ft) for normal assembly applications unless otherwise stated

NOTICE: Shown below is the suggested initial torque tightening sequences for general applications, tighten in sequence from item 1 through to the last item of the hardware.

The minimum hardware tightening torque on drawings, in specifications etc. have priority. The applicable CNH Standard is ENS7001.

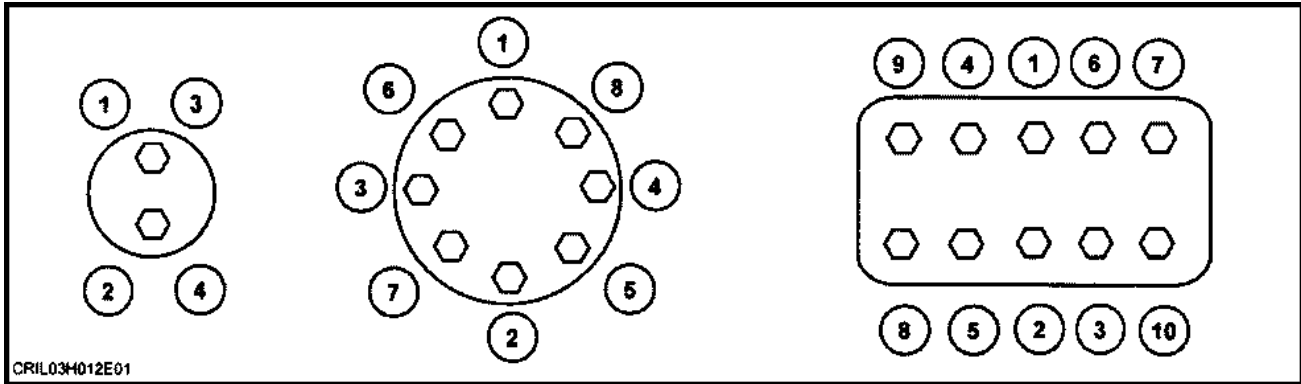

CRIL03H012E01

DF5019-1 1



Metric hardware

Nominal Size	Class 8.8 in N m (lb in or lb ft)			Class 10.9 in N m (lb in or lb ft)		
	Plated nut	Lock nut	Hardened nut	Plated nut	Lock nut	Hardened nut
M3	1.3 N·m (11.5 lb in)	0.7 N·m (6.2 lb in)	1.2 N·m (10.6 lb in)	1.8 N·m (15.9 lb in)	0.9 N·m (8.0 lb in)	1.6 N·m (14.2 lb in)
M4	2.9 N·m (25.7 lb in)	1.6 N·m (14.2 lb in)	2.6 N·m (23.0 lb in)	4.2 N·m (37.2 lb in)	2.3 N·m (20.4 lb in)	3.7 N·m (32.7 lb in)
M5	5.9 N·m (52.2 lb in)	3.2 N·m (28.3 lb in)	5.3 N·m (46.9 lb in)	8.5 N·m (75.2 lb in)	4.6 N·m (40.7 lb in)	7.6 N·m (67.3 lb in)
M6	10.1 N·m (89.4 lb in)	5.5 N·m (48.7 lb in)	9.1 N·m (80.5 lb in)	14.5 N·m (10.7 lb ft)	7.9 N·m (69.9 lb in)	13 N·m (9.6 lb ft)
M8	24.5 N·m (18.1 lb ft)	13.5 N·m (10.0 lb ft)	22 N·m (16.2 lb ft)	35.1 N·m (25.9 lb ft)	19.3 N·m (14.2 lb ft)	31.5 N·m (23.2 lb ft)
M10	48.7 N·m (35.9 lb ft)	26.8 N·m (19.8 lb ft)	43.8 N·m (32.3 lb ft)	69.5 N·m (51.3 lb ft)	38.2 N·m (28.2 lb ft)	62.5 N·m (46.1 lb ft)
M12	85 N·m (62.7 lb ft)	46.7 N·m (34.4 lb ft)	76.5 N·m (56.4 lb ft)	121 N·m (89.2 lb ft)	66.5 N·m (49.0 lb ft)	108.9 N·m (80.3 lb ft)
M14	135 N·m (99.6 lb ft)	74.2 N·m (54.7 lb ft)	121.5 N·m (89.6 lb ft)	193 N·m (142.3 lb ft)	106.1 N·m (78.3 lb ft)	173.7 N·m (128.1 lb ft)
M16	210 N·m (154.9 lb ft)	115.5 N·m (85.2 lb ft)	189 N·m (139.4 lb ft)	301 N·m (222 lb ft)	165.5 N·m (122.1 lb ft)	270.9 N·m (199.8 lb ft)
M18	299 N·m (220.5 lb ft)	164.4 N·m (121.3 lb ft)	269.1 N·m (198.5 lb ft)	414 N·m (305.4 lb ft)	227.7 N·m (167.9 lb ft)	372.6 N·m (274.8 lb ft)
M20	425 N·m (313.5 lb ft)	233.72 N·m (172.4 lb ft)	382.5 N·m (282.1 lb ft)	587 N·m (432.9 lb ft)	322.8 N·m (238.1 lb ft)	528.3 N·m (389.7 lb ft)
M22	579 N·m (427 lb ft)	318.4 N·m (234.8 lb ft)	521.1 N·m (384.3 lb ft)	801 N·m (590.8 lb ft)	440.5 N·m (324.9 lb ft)	720.9 N·m (531.7 lb ft)
M24	735 N·m (542.1 lb ft)	404.2 N·m (298.1 lb ft)	661.5 N·m (487.9 lb ft)	1016 N·m (749.4 lb ft)	558.8 N·m (412.1 lb ft)	914.4 N·m (674.4 lb ft)
M27	1073 N·m (791.4 lb ft)	590.1 N·m (435.2 lb ft)	967.5 N·m (713.6 lb ft)	1486 N·m (1096 lb ft)	817.3 N·m (602.8 lb ft)	1337 N·m (986.1 lb ft)
M30	1461 N·m (1077.6 lb ft)	803.5 N·m (592.6 lb ft)	1315 N·m (969.9 lb ft)	2020 N·m (1489.9 lb ft)	1111 N·m (819.4 lb ft)	1818 N·m (1340.9 lb ft)

IDENTIFICATION HEX CAP SCREW AND CARRIAGE BOLTS



SAE GRADE 2

SAE GRADE 5



SAE GRADE 8

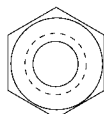

REGULAR NUTS

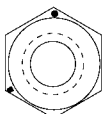

SAE GRADE 5
HEX NUTS

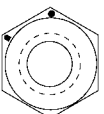

SAE GRADE 8
HEX NUTS

LOCKNUTS

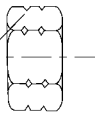

GRADE IDENTIFICATION
GRADE A: NO NOTCHES
GRADE B: ONE CIRCUMFERENTIAL NOTCH
GRADE C: TWO CIRCUMFERENTIAL NOTCHES

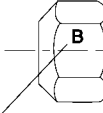

GRADE A: NO MARK
GRADE B: LETTER B
GRADE C: LETTER C

GRADE IDENTIFICATION

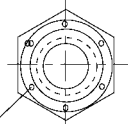

GRADE IDENTIFICATION
GRADE A: NO MARKS
GRADE B: THREE MARKS
GRADE C: SIX MARKS

ZEIL06CS0136F0A

ZEIL06CS0136F0A 2

IDENTIFICATION HEX CAP SCREW AND CARRIAGE BOLTS CLASSES 5,6 AND UP

MANUFACTURER'S IDENTIFICATION

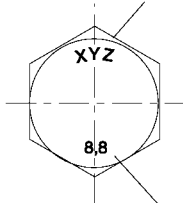

PROPERTY CLASS

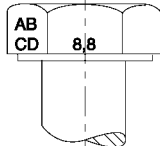

HEX NUTS AND LOCKNUTS CLASSES 05 AND UP

MANUFACTURER'S IDENTIFICATION

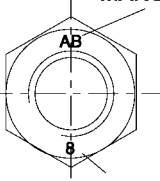

PROPERTY CLASS

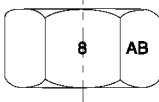

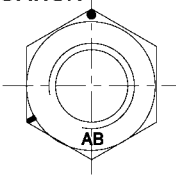

CLOCK MARKING

ZEIL06CS0135F0A

ZEIL06CS0135F0A 3

Basic instructions

SHIMMING

For each adjustment operation, select adjusting shims and measure individually using a micrometer, then add up the recorded values. Do not rely on measuring the entire shimming set, which may be incorrect, or the rated value indicated on each shim.

ROTATING SHAFT SEALS

For correct rotating shaft seal installation, proceed as follows:

- before assembly, allow the seal to soak in the oil it will be sealing for at least thirty minutes
- thoroughly clean the shaft and check that the working surface on the shaft is not damaged
- position the sealing lip facing the fluid; with hydrodynamic lips, take into consideration the shaft rotation direction and position the grooves so that they will deviate the fluid towards the inner side of the seal
- coat the sealing lip with a thin layer of lubricant (use oil rather than grease) and fill the gap between the sealing lip and the dust lip on double lip seals with grease
- insert the seal in its seat and press down using a flat punch, do not tap the seal with a hammer or mallet
- whilst inserting the seal, check that it is perpendicular to the seat; once settled, make sure that it makes contact with the thrust element, if required
- to prevent damaging the seal lip on the shaft, position a protective guard during installation operations

O-RING SEALS

Lubricate the O-RING seals before inserting them in the seats, this will prevent them from overturning and twisting, which would jeopardize sealing efficiency.

SEALING COMPOUNDS

Only use the sealants which are recommended in this manual! Before applying the sealing compound, prepare the surfaces as follows:

- remove any incrustations using a metal brush;
- thoroughly de-grease the surfaces using one of the following cleaning agents: trichlorethylene, petrol or a water and soda solution.

COTTER PINS

When fitting split cotter pins, ensure that the pin notch is positioned in the direction of the force required to stress the pin. Spiral cotter pins do not require special positioning.

PROTECTING THE ELECTRONIC/ ELECTRICAL SYSTEMS DURING CHARGING OR WELDING

▲ WARNING

Battery acid causes burns. Batteries contain sulfuric acid. Avoid contact with skin, eyes or clothing. Antidote (external): Flush with water. Antidote (eyes): flush with water for 15 minutes and seek medical attention immediately. Antidote (internal): Drink large quantities of water or milk. Do not induce vomiting. Seek medical attention immediately. Failure to comply could result in death or serious injury.

W0111A

To avoid damage to the electronic/electrical systems, always observe the following:

1. Never make or break any of the charging circuit connections, including the battery connections, when the engine is running.
2. Never short any of the charging components to ground.
3. Always disconnect the ground cable from the battery before arc welding on the unit.
 - Position the welder ground clamp as close to the welding area as possible.
 - If welding in close proximity to a computer module, then the module should be removed from the unit.
 - Never allow welding cables to lay on, near or across any electrical wiring or electronic component while welding is in progress.
4. Always disconnect the negative cable from the battery when charging the battery in the unit with a battery charger.

NOTICE: *If welding must be performed on the unit, the battery ground cable must be disconnected from the battery. The electronic monitoring system and charging system will be damaged if this is not done.*

SPARE PARTS

Only use "CNH Original Parts" or "NEW HOLLAND Parts".

Only genuine spare parts guarantee the same quality, duration and safety as original parts, as they are the same parts that are assembled during standard production. Only "CNH Original Parts" or "NEW HOLLAND Parts" can offer this guarantee. When ordering spare parts, always provide the following information:

- Machine model (commercial name) and serial number
- part number of the ordered part, which can be found in the "Spare Parts Catalogue", used for order processing

TOOLS

The tools that NEW HOLLAND suggests and illustrate in this manual have been:

- specifically researched and designed for use with NEW HOLLAND machines
- essential for reliable repair operations
- accurately built and rigorously tested so as to offer efficient and long-lasting operation

By using these tools, Repair Personnel will benefit from:

- operating in optimal technical conditions
- obtaining the best results
- saving time and effort
- working in safe conditions

NOTE: *Wear limit values indicated for certain parts should be considered to be recommended, but not binding. The terms "front", "rear", "right-hand" and "left-hand" (when referred to different parts) are determined from the rear, facing in the direction of travel of the machine during operation.*

Conversion factors

Length

1 mm	=	0.0393 in	1 in	=	25.4 mm
1 km	=	0.621 miles	1 miles	=	1.609 km
1 m	=	3.281 ft	1 ft	=	0.3048 m

Area

1 ha	=	2.471 ac	1 ac	=	0.404 US fl oz
1 m ²	=	10.76 ft ²	1 ft ²	=	0.0923 m ²

Volume

1 litre	=	0.26 US gal	1 US gal	=	3.78 litre
1 litre	=	0.028 Bu	1 Bu	=	35.23 litre
1 litre	=	1.057 US quart	1 US quart	=	0.9464 litre
1 cm ³ (cc)	=	0.061 in ³	1 in ³	=	16.38 cm ³ (cc)
1 m ³	=	35.31 ft ³	1 ft ³	=	0.028 m ³
1 ml	=	0.033 US fl oz	1 US fl oz	=	29.57 ml

Mass

1 kg	=	2.204 lb	1 lb	=	0.4536 kg
------	---	----------	------	---	-----------

Torque

1 N·m	=	0.7376 lb ft	1 lb ft	=	1.3558 N·m
-------	---	--------------	---------	---	------------

Power

1 kW	=	1.358 Hp	1 Hp	=	0.746 kW
------	---	----------	------	---	----------

Pressure

1 bar	=	100 kPa			
1 bar	=	14.505 psi	1 psi	=	0.06894 bar

Temperature

1 °C	=	((1.8 x ° C) + 32) °F	1 °F	=	(0.56 x (° F - 32)) °C
------	---	-----------------------	------	---	------------------------

Flow

1 l/min	=	0.2642 US gpm	1 US gpm	=	3.7853 l/min
---------	---	---------------	----------	---	--------------

Speed

1 km/h	=	0.62 mph	1 mph	=	1.6 km/h
--------	---	----------	-------	---	----------

Consumables Lubrications and Coolants

Lubrications

The correct engine oil viscosity grade is dependent upon ambient temperature. Refer to the chart when selecting oil for your tractor engine.

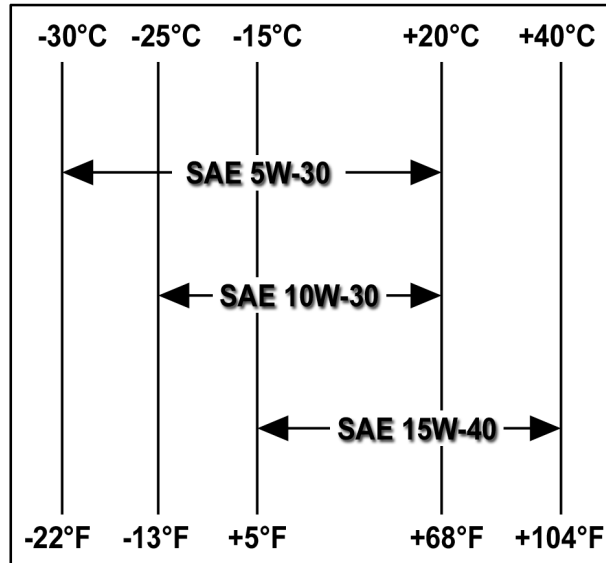

SS09J076 1

NOTE: In areas where prolonged periods of extreme temperatures are encountered, local lubricant practices are acceptable; such as the use of **SAE 5W30** in extreme low temperatures or **SAE 50** in extreme high temperatures.

Biodegradable transmission and hydraulic oil

⚠ WARNING

Burn hazard!

Be very careful to avoid contact with hot fluids. If fluid is extremely hot, allow it to cool to a moderately warm temperature before proceeding.

Failure to comply could result in death or serious injury.

W0362A

A biodegradable oil has been approved for use in the transmission, 4WD front axle and hubs, and the hydraulic system of your tractor. Although the oil is **90 %** biodegradable, it is important to follow safe handling and disposal practices.

The **NEW HOLLAND AMBRA MULTI BIO** oil is available from your authorized dealer.

Biodegradable oil should not be used in conjunction with other oils. Use the following procedure to replace standard oil with biodegradable lubricant.

1. Operate the tractor until the oil that is being changed reaches a temperature greater than **60 °C (140 °F)**.
2. Stop the engine and immediately drain the oil.
3. Replace all transmission and hydraulic filters.
4. Add the biodegradable oil to the correct level and run the tractor to circulate the oil.
5. Check for oil leaks and recheck the oil level.

**Thanks very much for your reading,
Want to get more information,
Please click here, Then get the complete
manual**

JustClickHere 

NOTE:

**If there is no response to click on the link above,
please download the PDF document first, and then
click on it.**

**Have any questions please write to me:
admin@servicemanualperfect.com**